

LISTBEL V15 250

Nastri / Belts



Dimensioni listelli/ Listel dimensions

Valore / value

A	mm	600
B	mm	385
C	mm	107,5
D	mm	250
α	°	60

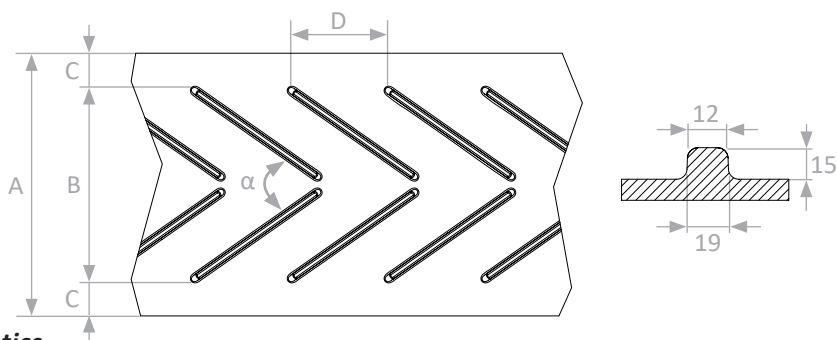

Caratteristiche del nastro / Belt characteristics

	Um	Norme / norms	Valore / value
Peso / weight	Kg/m ²		8,63
Carico di rottura / tensile strenght	Kg/cm	ISO 283	250
Adesioni coperture / adhesions cover	N/mm	DIN 22102	≥ 4,5
Adesioni tela tela / adhesions fabric to fabric	N/mm	DIN 22102	≥ 5
Spessore coperture superiore / top cover thickness	mm	DIN 22102	3
Spessore coperture inferiore / bottom cover thickness	mm	DIN 22102	1,5
Spessore totale / total rhickness	mm	DIN 22102	6,5
Numero tele / fabric number	n°	DIN 22102	2
Composizione tessuto / fabric composition		DIN 22102	EP 125
Diam. tamburo motore / min. diam. motor pulley	mm		-
Diam. tamburo di coda / min. diam. tail pulley	mm		-
Temperatura di esercizio / operating temperature	min. / max °C		-25 ÷ +70

Caratteristiche delle coperture / Cover characteristics

	Um	Norme / norms	Valore / value
Grado copertura / cover grade		DIN 22102	Y
Carico di rottura / tensile strenght	daN/cm ²	DIN 22102	20
Allungamento a rottura / elongation at breaking	%	DIN 22102	400
Perdita all'abrasione / abrasion loss	mm ³	DIN 22102	150
Durezza / hardness	SH/A		65

Tabella Tolleranze / Table Tolerances

	da / from	a / to	Um	tolleranze / tolerances
Durezza / hardness	-	-	SH/A	± 5
Larghezza	-	-	mm	± 10
Spessore totale / Total thickness	-	-	mm	± 0,8

